

MAMOLI
MILANO 1932

MENDINI

DESIGNED BY
Alessandro Mendini





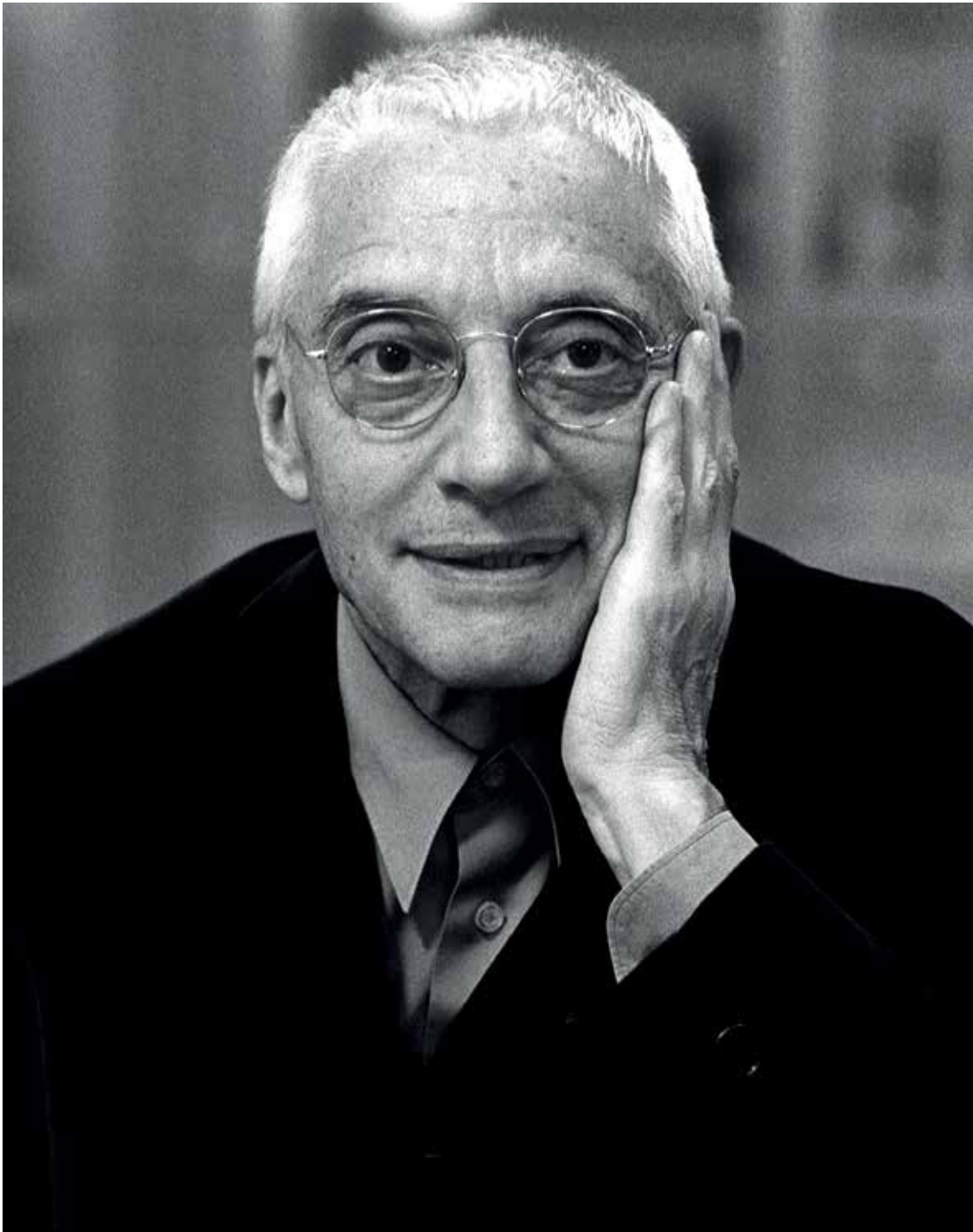

Alessandro Mendini

1931 - 2019

Intellettuale, progettista e architetto visionario, tra i più grandi innovatori del design italiano degli ultimi 50 anni. Nel 2014 riceve il Compasso d'oro come riconoscimento al lavoro di una vita. Per Mamoli ha disegnato la serie a cui oggi diamo il suo nome.

Alessandro Mendini

1931 - 2019

Intellectual, designer and visionary architect, one of the greatest innovators of Italian design of the last 50 years. In 2014 he received the Compasso d'Oro in recognition of his life's work. For Mamoli he designed the series to which we now give his name.

“Da tempo avevo in mente di disegnare un rubinetto costituito da un parallelepipedo. Un volume elementare da cui far uscire dell’acqua. Sezioni quadre e schematiche, linee parallele, superfici diritte, piatte e lucide. Mamoli mi ha fornito questa occasione. Ha approfondito la tecnica e le funzioni, poi abbiamo articolato tutta la serie, con grande piacere e velocità.”

Alessandro Mendini 2004

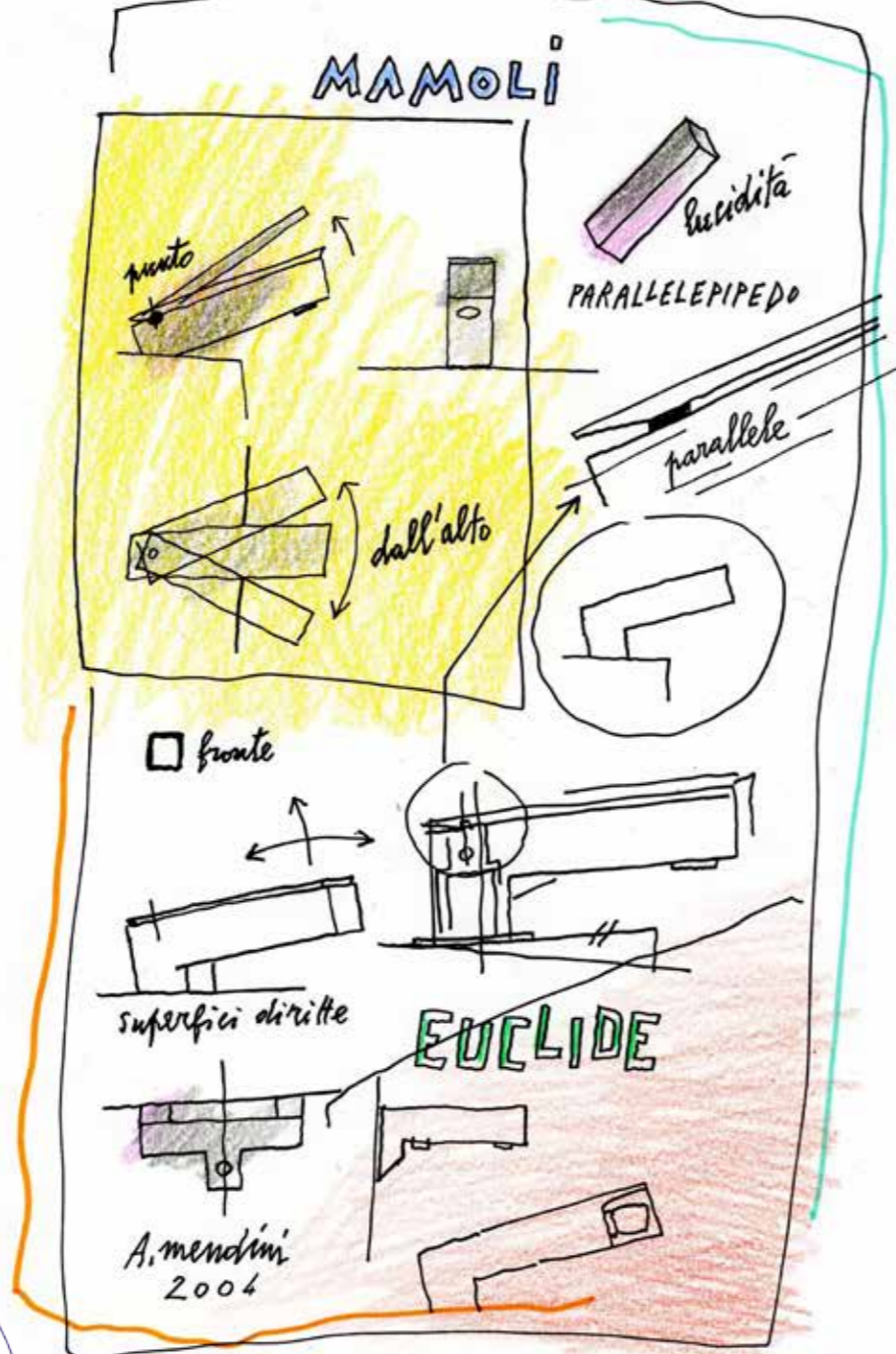

“For some time now I had been thinking about designing a tap in the form of a parallelepiped. A basic volume from which water would pour. Square and schematic sections, parallel lines, straight, flat and polished surfaces. I was given this opportunity by Mamoli. They studied the technique and the functions and then we prepared the whole series, with great pleasure and speed.”

Alessandro Mendini 2004

Nei primi anni 2000 volevamo un rubinetto dal disegno così elementare da risultare senza tempo. Schematico, essenziale, pulitissimo, elegante, fatto di superfici piatte, tagliate dalla luce. Un rubinetto geometrico, semplice in teoria, ma che non somigliasse a nient’altro.

Nel 2004 lo disegna per Mamoli Alessandro Mendini, che lo chiama EUCLIDE, descrivendolo come “forma primaria di geometria antica.” Elementare e unico, quel rubinetto diventa un’icona tra le nostre serie. Oggi, dopo vent’anni di onorata carriera, ci sembra bello cambiargli nome, dandogli quello del suo creatore.

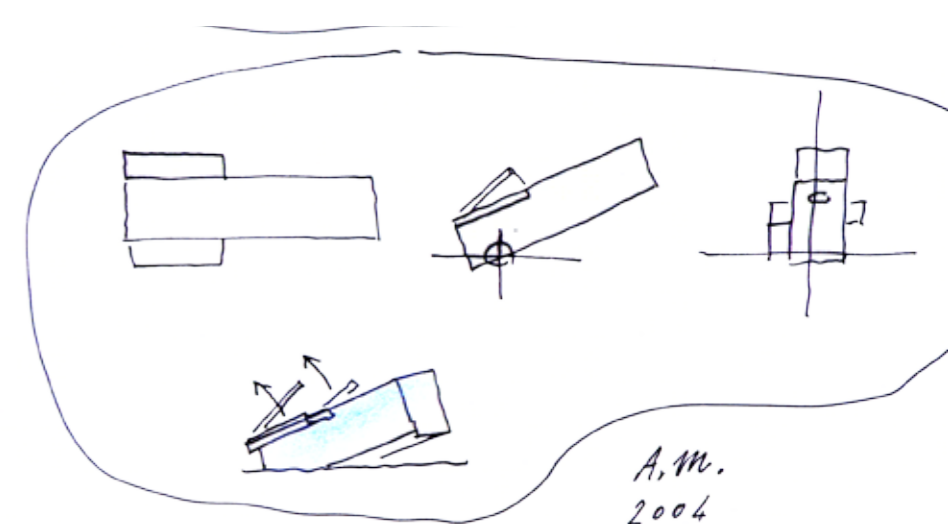

In the early 2000s, we wanted a faucet with a design so basic that it was timeless. Schematic, essential, very clean, elegant, made of flat surfaces, cut by light. A geometric faucet, simple in theory, but resembling nothing else. In 2004 he designed it for Mamoli Alessandro Mendini, who calls it EUCLIDE, describing it as “a primary form of ancient geometry.” Elementary and unique, that faucet becomes an icon among our series. Today, after twenty years of honorable career, it seems nice to change its name, giving it that of its creator.



Dark + Light + Gold

Small + Medium + Tall





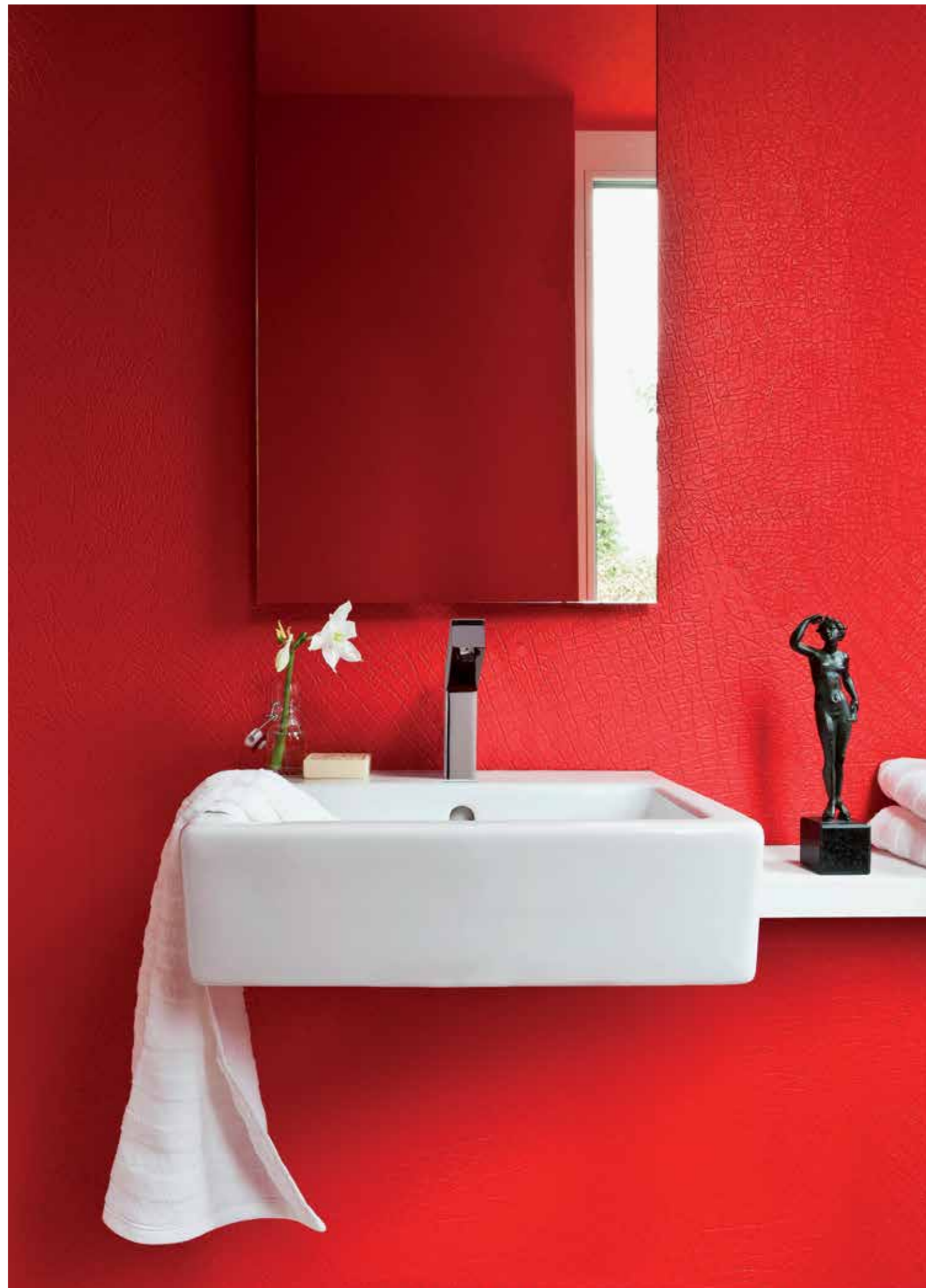





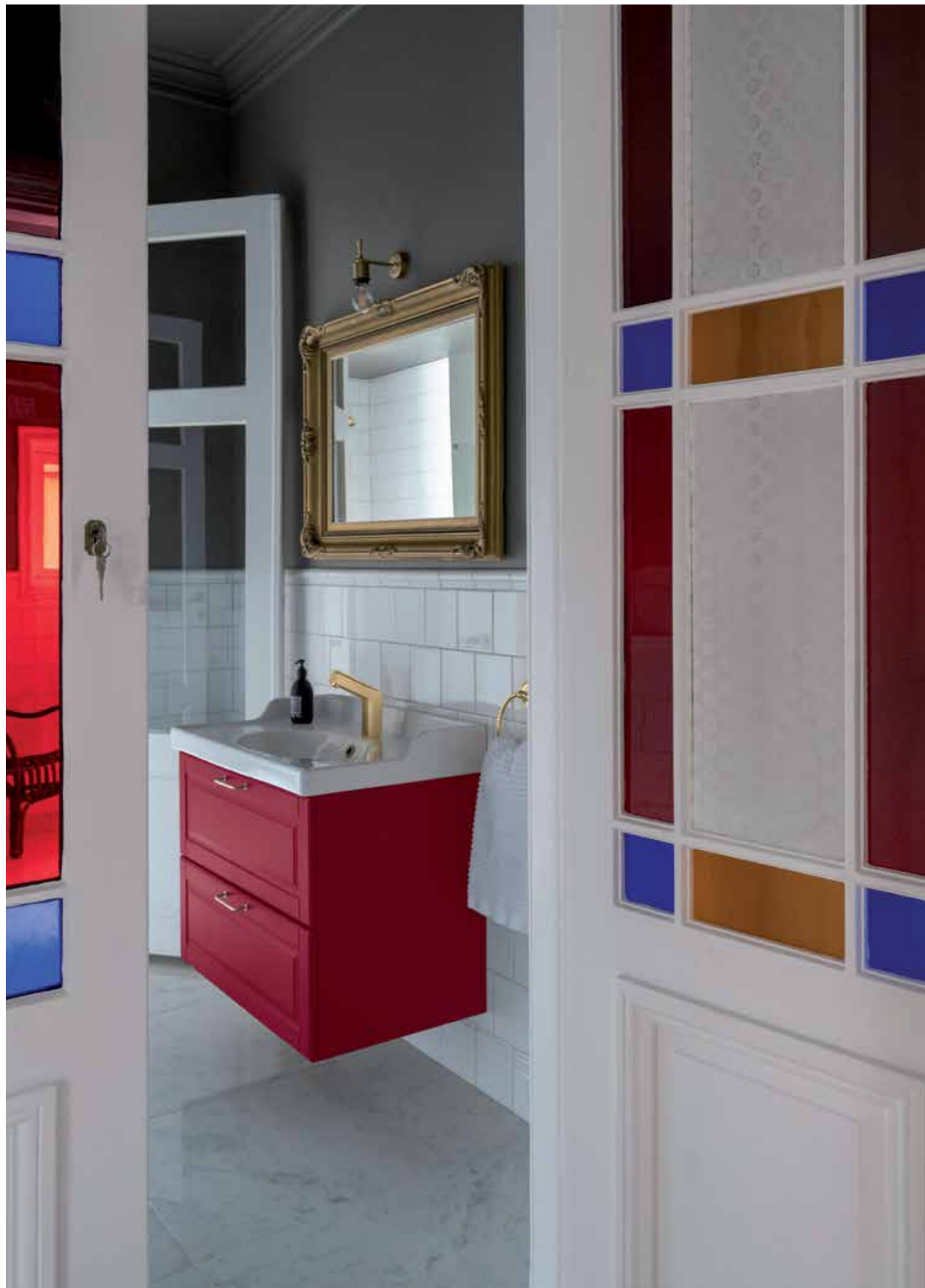



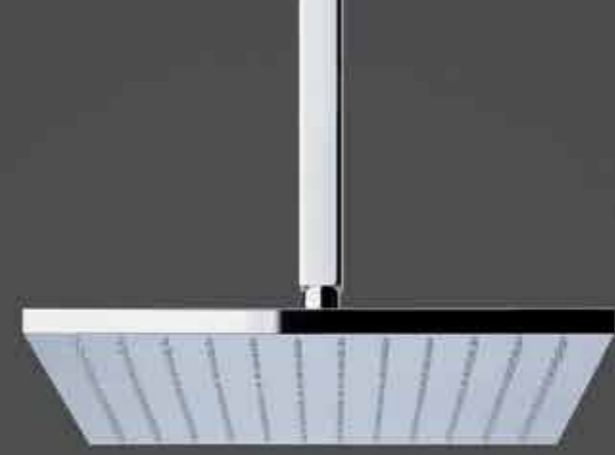



CODICE/CODE	EURO
48540000C051	260,00
48540000C05G	345,00
48540000C05K	310,00

Miscelatore monocomando per lavabo con scarico da 5/4" con comando a pressione
Single lever basin mixer with 5/4" up&down system pop-up waste

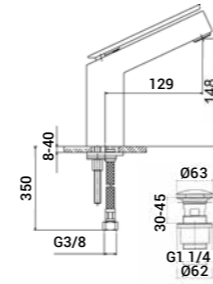

48560000C001	270,00
48560000C00G	355,00
48560000C00K	320,00

Miscelatore monocomando per lavabo alto senza scarico
High single lever basin mixer without pop-up waste

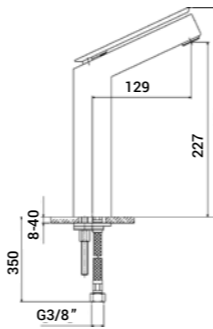

48510000C051	260,00
48510000C05K	310,00

Miscelatore monocomando per lavabo con scarico da 5/4" con comando a pressione
Single lever basin mixer with 5/4" up&down system pop-up waste

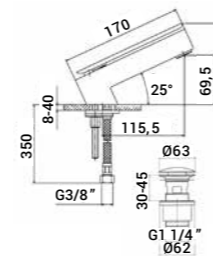

48580000C021	390,00
48580000C02G	530,00
48580000C02K	470,00

Miscelatore monocomando da incasso per lavabo, composto da parte grezza e parte esterna di finitura e bocca a parete
Concealed single lever basin mixer, composed by assembly components, external components and wall-mounted spout

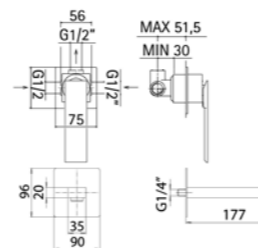

58510000C051	260,00
58510000C05G	345,00
58510000C05K	310,00

Miscelatore monocomando per bidet con scarico da 5/4" con comando a pressione
Single lever bidet mixer with 5/4" up&down system pop-up waste

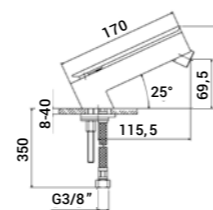

CODICE/CODE	EURO
-------------	------

1850PD40C121	590,00
1850PD40C12K	690,00

Miscelatore monocomando esterno per vasca con deviatore automatico ed accessorio doccia fisso
Exposed single lever bath mixer with automatic diverter and fixed shower set

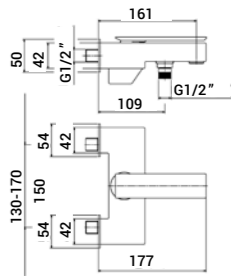

2858PE00C001	230,00
2858PE00C00G	310,00
2858PE00C00K	275,00

Parte esterna di finitura per miscelatore monocomando da incasso per doccia con deviatore automatico a 2 uscite
External components for concealed single lever shower mixer 2-ways automatic diverter

Da completare con gruppo da incasso 270700000027
To be completed with concealed mixer 270700000027

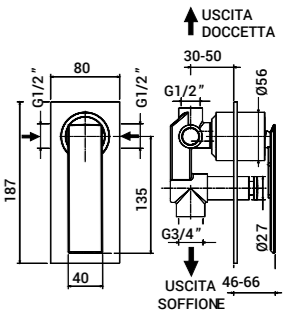

270700000027	137,40
--------------	--------

Gruppo monocomando doccia da incasso con deviatore a 2 uscite
Concealed single lever shower mixer with 2-ways automatic diverter

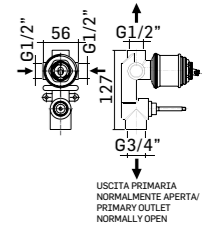

3858PE00C001	180,00
3858PE00C00G	240,00
3858PE00C00K	220,00

Parte esterna di finitura per miscelatore monocomando da incasso per doccia ad 1 uscita
External components for concealed single lever shower mixer 1-way

Da completare con gruppo da incasso 370700000027
To be completed with concealed mixer 370700000027

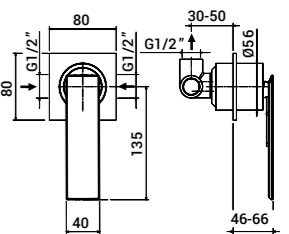

370700000027	65,40
--------------	-------

Gruppo monocomando da incasso per doccia ad 1 uscita
Concealed single lever shower mixer with 1-way

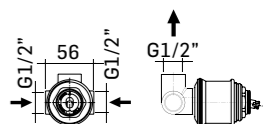

CODICE/CODE EURO



- 28540000C021 308,10
- 28540000C02K 380,20

Deviatore da incasso a 3 uscite, composto da parte grezza e parte esterna di finitura
Concealed 3-ways diverter composed by assembly components and external components

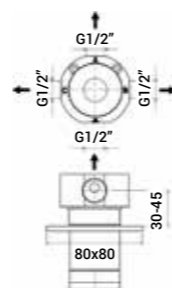

CODICE/CODE EURO

- 0000855S001 182,10

Soffione 300x300 mm, in acciaio inox 18/10, getto a pioggia, sistema anticalcare
300x300 mm shower head, made of 18/10 stainless steel, rain jet with anti-lime system



- 38530000C021 529,00
- 38530000C02K 643,50

Miscelatore monocomando esterno doccia
Single lever shower mixer

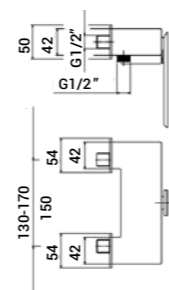

- 0000857S001 154,60

Soffione 200x200 mm, in ottone, getto a pioggia, sistema anticalcare
200x200 mm brass shower head, inspectable, rain jet with anti-lime system

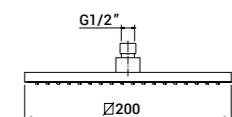

- 3248PE000001 248,60
- 3248PE00000K 324,00

Parte esterna di finitura per miscelatore termostatico incasso per doccia con deviatore a 2 uscite
External components for concealed thermostatic shower mixer 2-ways diverter

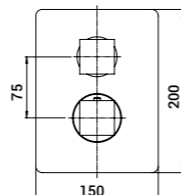

- 0000858S001 213,00
- 0000858S00G 480,00
- 0000858S00K 377,80

Soffione 300x300 mm, in ottone getto a pioggia, sistema anticalcare
300x300 mm brass shower head, inspectable, rain jet with anti-lime system

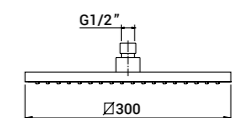

Da completare con gruppo termostatico da incasso 271000000027
To be completed with concealed thermostatic mixer 271000000027



- 271000000027 223,30

Gruppo doccia incasso termostatico universale con deviatore a 2 uscite
Universal built-in thermostatic shower mixer with 2 ways diverter

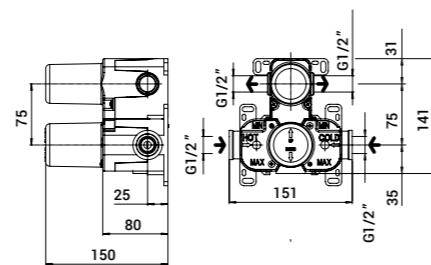

- 0000345L301 143,10

Braccio in ottone con fissaggio di sicurezza per installazione a parete L=300 mm
Brass shower arm with security fixing kit, L= 300 mm

- 0000345L401 167,20
- 0000345L40G 240,50
- 0000345L40K 229,00

Braccio in ottone con fissaggio di sicurezza per installazione a parete L=400 mm
Brass shower arm with security fixing kit, L= 400 mm

Articolo raccomandato per soffioni da 300 mm e 400 mm
Recommended product for 300 mm and 400 mm shower head

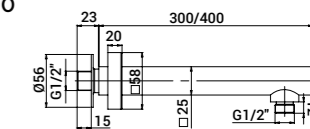

- 0000854S001 94,00

Soffione 200x200 mm, in acciaio inox 18/10, getto a pioggia, sistema anticalcare
200x200 mm shower head, made of 18/10 stainless steel, rain jet with anti-lime system

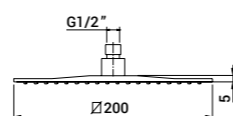

- 0000851H201 59,70

Braccio quadro 25x25 mm con fissaggio di sicurezza per installazione a soffitto L=200 mm
Square ceiling shower arm with security fixing kit, L= 200 mm

Articolo raccomandato per soffioni da 300 mm e 400 mm
Recommended product for 300 mm and 400 mm shower head

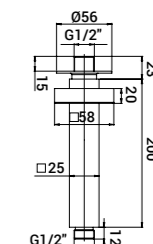

CODICE/CODE EURO



■ 383708420021 798,10

Colonna doccia, con miscelatore termostatico esterno con soffione 250x250 mm in acciaio inox e doccia monogetto
Shower column with thermostatic mixer with 250x250 mm stainless steel shower head and handshower

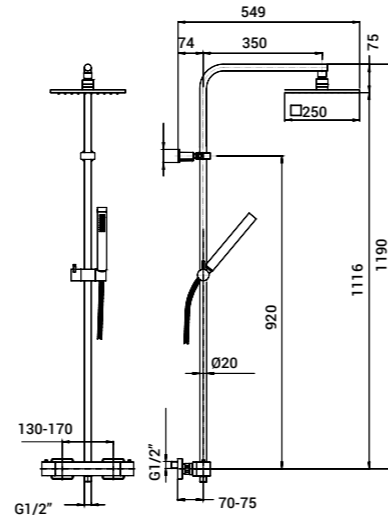

■ 38470852002K 1.213,50

Colonna doccia con miscelatore termostatico esterno con deviatore integrato, soffione 200x200 mm regolabile in altezza con interasse fisso ed accessorio doccia
Shower column with thermostatic mixer, integrated diverter and adjustable 200x200 mm shower head and shower set, fixed centres.

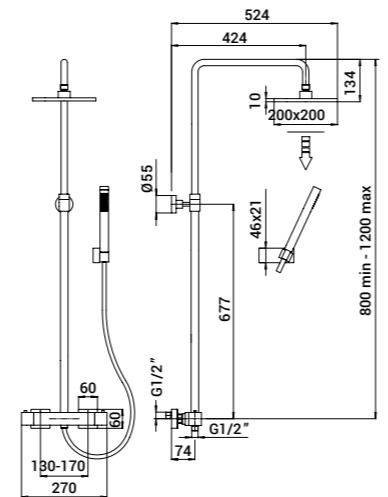

■ 0000PU40Q001 269,10

Asta saliscendi con doccia getto a pioggia
Shower bar with rain jet handshower

■ 000003520121 61,90

Presse d'acqua a parete
Wall outlet

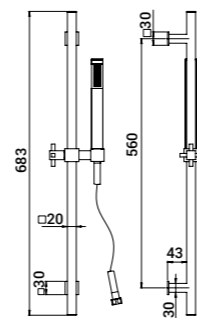

CODICE/CODE EURO

■ 0000PU40Q00K 354,90

Asta saliscendi con doccia getto a pioggia
Shower bar with rain jet handshower

■ 00000352012K 99,70

Presse d'acqua a parete
Wall outlet

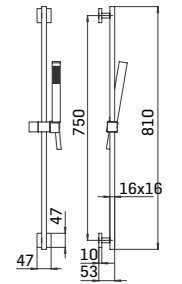

■ 30450000D121 296,60

Miscelatore termostatico esterno doccia, con rubinetto di regolazione e di chiusura con vitone a dischi ceramici e con limitatore di sicurezza a 38° C
Exposed thermostatic shower mixer temperature control handle with stop valve, water flow regulation and safety block at 38°C

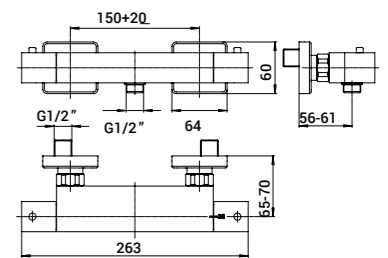

■ 0000PO400121 168,40

■ 0000FO40012G 310,50

■ 0000PO40012K 280,50

Accessorio doccia orientabile con presa acqua
Adjustable shower set, bracket with water outlet

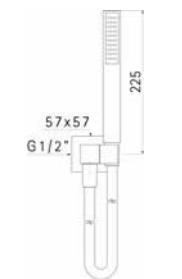

■ 0000PD400001 177,50

■ 0000PD40000K 208,50

Accessorio doccia fisso
Fixed shower set

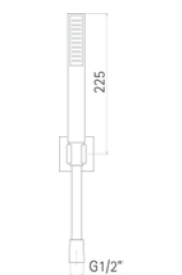

CODICE/CODE EURO



000003520121	61,90
00000352012K	99,70

Pres a d'acqua a parete
Wall outlet



CODICE/CODE EURO

00000588L45I	230,00
00000588L45G	277,00
00000588L45K	272,00

Portasalviette 45 cm
Towel holder cm 45

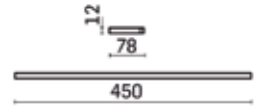

22170000D121	235,90
22170000D12K	294,30

Bocca di erogazione a parete
Wall-mounted spout

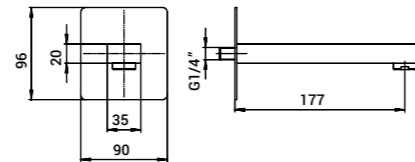

00000588L30I	215,00
00000588L30G	260,00
00000588L30K	255,00

Portasalviette 30 cm
Towel holder cm 30

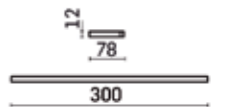

6641PE00C001	161,10
6641PE00C00K	228,70

Parte esterna per passo rapido incasso
Da completare con passo rapido da 3/4"o 1" - 6601PI0000*1
External components for concealed flushvalve G.3/4"
To be completed with 3/4"o 1" concealed flushvalve - 6601PI0000*1

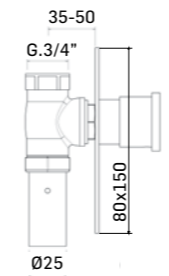

000005830001	290,00
00000583000G	315,00
00000583000K	310,00

Portascopino
Toilet brush set

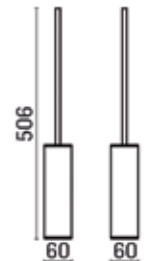

6601PI000031	59,90
--------------	-------

Parte grezza passo rapido
incasso da G.3/4" per WC
Assembly components G.3/4"
for concealed flushvalve

6601PI000041	71,40
--------------	-------

Parte grezza passo rapido
incasso da G.1" per WC
Assembly components G.1"
for concealed flushvalve

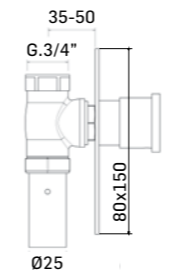

000005820001	100,00
00000582000G	125,00
00000582000K	120,00

Portabitì
Hook

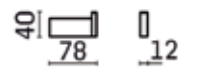

000004430051	36,80
00000443005G	82,60
00000443005K	68,70

Scarico per lavabo da 5/4" con comando a pressione,
con troppopieno, spessore installazione 30-45 mm
5/4" up&down system pop-up waste
for wash basin. On surfaces up 30-45 mm

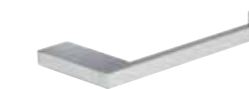
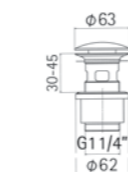

000005810001	135,00
00000581000G	165,00
00000581000K	160,00

Portarotolo
Toilet paper holder

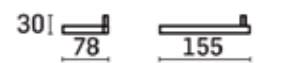

MAMOLI
MILANO 1932

Mamoli S.r.l.
via Camillo Benso Conte di Cavour, 71
46043 Castiglione delle Stiviere (MN) Italia

Tel. +39 0376 1872820

www.mamoli.com
info@mamoli.com
